

Nucleate Boiling Heat Transfer Coefficients of Mixtures Containing Propane, Isobutane and HFC134a

Ki-Jung Park, Dongsoo Jung*

Department of Mechanical Engineering, Inha University,
253, Yonghyundong, Namgu, Incheon 402-751, Korea

Nucleate pool boiling heat transfer coefficient (HTCs) were measured with one nonazeotropic mixture of propane/isobutane and two azeotropic mixtures of HFC134a/isobutane and propane/HFC134a. All data were taken at the liquid pool temperature of 7°C on a horizontal plain tube of 19.0 mm outside diameter with heat fluxes of 10 kW/m² to 80 kW/m² with an interval of 10 kW/m² in the decreasing order of heat flux. The measurements were made through electrical heating by a cartridge heater. The nonazeotropic mixture of propane/isobutane showed a reduction of HTCs as much as 41% from the ideal values. The azeotropic mixtures of HFC134a/isobutane and propane/HFC134a showed a reduction of HTCs as much as 44% from the ideal values at compositions other than azeotropic compositions. At azeotropic compositions, however, the HTCs were even higher than the ideal values due to the increase in the vapor pressure. For all mixtures, the reduction in heat transfer was greater with larger gliding temperature difference. Stephan and Körner's and Jung et al's correlations predicted the HTCs of mixtures with a mean deviation of 11%. The largest mean deviation occurred at the azeotropic compositions of HFC134a/isobutane and propane/HFC134a.

Key Words : Nucleate Boiling Heat Transfer Coefficients, Alternative Refrigerants, Hydrocarbons, Binary Mixtures, Pool Boiling Correlation, Evaporator

Nomenclature

A : Heat transfer area [m²]
 C : Constant or exponent
 D : Diameter [m]
 g : Gravitational acceleration [m/s²]
 h : Heat transfer coefficient [W/m²K]
 K : Heat transfer reduction factor for mixtures
 k : Thermal conductivity [W/m·K]
 P : Pressure [kPa]
 Q : Heat transfer rate [W]
 T : Temperature [K or °C]
 ΔT : Temperature difference [K or °C]

x : Liquid mole composition
 y : Vapor mole composition

Greek symbols

β : Contact angle [°]
 μ : Viscosity [Pa·s]
 ρ : Density [kg/m³]
 σ : Surface tension [N/m]

Subscripts

b : Bulk
 bl : Bubble
 bp : Bubble point
 cal : Calculated values
 eff : Effective
 epf : Equivalent pure fluid
 exp : Experimental values
 f : Saturated liquid
 g : Saturated vapor
 id : Ideal

* Corresponding Author,

E-mail : dsjung@inha.ac.kr

TEL : +82-32-860-7320; FAX : +82-32-868-1716

Department of Mechanical Engineering, Inha University, 253, Yonghyundong, Namgu, Incheon 402-751, Korea. (Manuscript Received April 20, 2005; Revised February 2, 2006)

Jung : Jung et al.

γ : Reduced property

S&K : Stephan and Körner's

sat : Saturation

1. Introduction

For the past few decades, CFCs have been used extensively in various refrigeration fields due to their excellent chemical and thermodynamic properties. Due to the stratospheric ozone layer depletion, however, many countries signed the Montreal Protocol for the phase-out of CFCs in 1987 and CFCs have been phased out and various alternatives have been proposed for the past years. Traditionally, flammable refrigerants have not been accepted in normal refrigeration and air-conditioning applications due to a safety concern. This trend, however, is somewhat relaxed these days due to an environmental mandate. Therefore, some of the flammable refrigerants have been applied to certain applications as a pure working fluid or as one of the components of mixed working fluids (Kruse, 1996; Jung et al., 2000). For instance, isobutane (R600a) has dominated the European refrigerator/freezer sector for the past decade (Kruse, 1996). Recently, such hydrocarbons as propane (R290) and propylene (R1270) are also proposed and actually used as working fluids in heat pumps for heating applications in Europe (IEAHPC, 2002). In fact, hydrocarbons are known to offer such advantages as a low cost, availability, compatibility with the conventional mineral oil, and environmental friendliness (Kruse, 1996; IEAHPC, 2002). Jung et al. (1999) demonstrated that propane and isobutane mixture is a good refrigerant to replace CFC12.

One way of reducing the flammability of the hydrocarbons is to mix them with nonflammable components such as HFC134a. For the successful application of such hydrocarbon/HFC mixtures in the evaporators, their nucleate boiling heat transfer coefficients (HTCs) are to be known. In fact, well designed heat exchangers with new refrigerant mixtures in refrigeration equipment would lead to an increase in system efficiency,

which in turn would alleviate the greenhouse warming. Even though mixtures of hydrocarbons and HFCs are proposed for possible alternatives for some refrigeration applications, systematic nucleate boiling heat transfer measurements have not been made to examine the mixture effect for those mixtures. In fact, understanding of nucleate boiling heat transfer with those mixtures is also very important for the development of flow boiling heat transfer correlation which requires most of the time the nucleate boiling contribution term in its final form.

In 1996, Thome (1996) made an excellent state of the art review for the boiling of new refrigerants and concluded that many features of existing correlations require refinement to attain the desired level of accuracy for refrigerant evaporator design. In 2001, Gorenflo (2001) reported another state of the art report in pool boiling heat transfer of new refrigerants, especially refrigerant mixtures, and indicated that improving a nucleate boiling correlation is necessary especially for mixtures that are used quite frequently these days.

Since Thome (1996) and Gorenflo (2001) presented excellent up to date literature surveys concerning boiling heat transfer of new halogenated refrigerants and their mixtures and also Collier and Thome (1996) and Balakrishnan (1998) summarized well a multi-component boiling phenomenon with theory and many prediction models, an interested reader is referred to these references for relevant information.

The objective of this paper is to measure and compare nucleate pool boiling HTCs of three binary mixtures of propane/isobutane, HFC134a/isobutane, and propane/HFC134a at various compositions. This work is designed mainly to provide a practical tool and data to the refrigeration industry for the design and manufacture of high efficiency evaporators of large chillers with those halogenated refrigerant mixtures. In fact, this is a sequel paper to our previous work for the nucleate boiling heat transfer with pure halogenated refrigerants and hydrocarbons (Jung et al., 2003a; 2004) and with HFC mixtures (Jung et al., 2003b).

2. Experiments

2.1 Experimental apparatus

In this work, nucleate boiling HTC's of propane/isobutane, HFC134a/isobutane, and propane/HFC134a at various compositions were measured on a plain tube of outside diameter of 19.0 mm using the same experimental apparatus with the same tube specimen described in Jung et al.(2003a). The experimental apparatus was specially designed to accommodate high vapor pressure refrigerants with a sight glass. A cartridge heater was used to generate uniform heat flux on the tube. Data were taken in the order of decreasing heat flux from 80 kW/m² to 10 kW/m² with an interval of 10 kW/m² in the pool temperature at 7°C. Figures 1 and 2 show the schematic diagram of the apparatus and heat transfer tube specimen. Since Jung et al.(2003a) contains all the details of the test apparatus, tube specimen and its manufacture, measurements, experimental procedure, data reduction scheme, fouling effect, repeatability of data, data verification etc., they will not be presented again here. An interested reader is referred to Jung et al.(2003a) for the details. In this work, only the measurement uncertainties will be reported, which were estimated by the method suggested by Kline and McClintock (1953). In general, the measurement

uncertainties were less than 7% at all heat fluxes. The repeatability of the experiment was always within 5% which was within the measurement uncertainties.

2.2 Refrigerant mixtures

In this study, one nonazeotropic binary refrigerant mixture and two azeotropic binary mixtures of different gliding temperature differences (GTDs) were selected. Propane/isobutane is a nonazeotropic mixture which has a maximum GTD of 8.06 K at the mole fraction of 0.57.

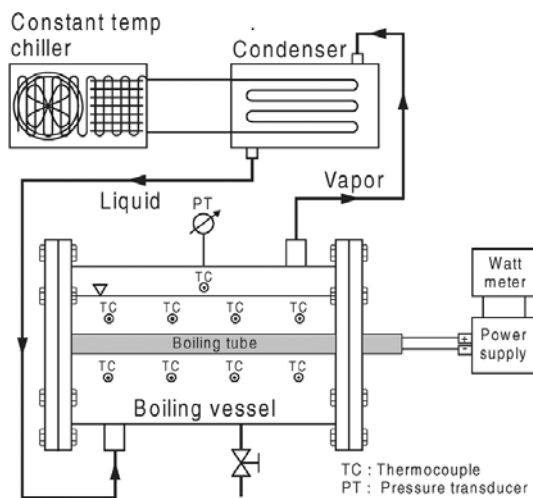

Fig. 1 Schematic diagram of the experimental apparatus

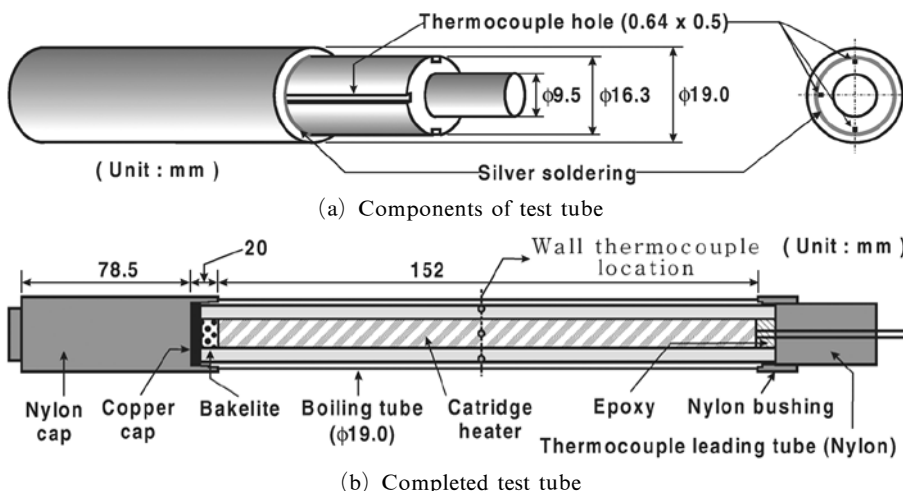

Fig. 2 Heat transfer tube specimen

Table 1 Compositions and GTDs of mixtures tested in this study at 7°C.

Mixture	Mass frac.	Mole frac.	GTD (°C)	Symbol
Propane/isobutane	0.25/0.75	0.31/0.69	6.54	A
	0.50/0.50	0.57/0.43	8.06	B
	0.75/0.25	0.80/0.20	5.91	C
HFC134a/isobutane	0.10/0.90	0.06/0.94	5.27	D
	0.35/0.65	0.23/0.77	9.59	E
	0.55/0.45	0.41/0.59	6.89	F
	0.85/0.15	0.76/0.24	0.04	G
	0.95/0.05	0.92/0.08	0.59	H
Propane/HFC134a	0.07/0.93	0.15/0.85	15.41	I
	0.10/0.90	0.20/0.80	15.20	J
	0.25/0.75	0.44/0.56	8.12	K
	0.45/0.55	0.65/0.35	0.08	L
	0.75/0.25	0.87/0.13	2.94	M

Table 2 Some properties of pure refrigerants at 7°C.

Refrigerant	P_{sat}	P_r	T_r	k_f	k_g	μ_f	μ_g	σ
	(kPa)			(W/m·K)		$\times 10^6$ (Pa·s)		
Propane	584.0	0.1375	0.7575	0.1019	0.01664	117.4	8.04	0.00923
HFC134a	374.6	0.0924	0.7487	0.0889	0.01213	248.0	11.02	0.01060
Isobutane	199.0	0.0548	0.6869	0.1036	0.01446	184.1	7.175	0.01220

HFC134a/isobutane is an azeotropic mixture forming an azeotrope at the mole fraction of about 0.76. It has the maximum GTD of 9.59 K at the mole fraction of 0.23. Finally, propane/HFC134a is another azeotropic mixture forming an azeotrope at the mole fraction of about 0.65. It has the maximum GTD of 15.41 K at the mole fraction of 0.15. Table 1 lists GTDs at the compositions where measurements were taken and Table 2 lists some properties of the pure refrigerants for reference. In this paper, GTDs and all thermodynamic and transport properties are all calculated by REFPROP (1998) and all compositions are the mole fractions of the more volatile components for given mixtures unless otherwise is mentioned.

3. Results and Discussion

In this study, nucleate boiling heat transfer measurements were carried out with three binary mixtures composed of propane, isobutane, and HFC134a. All data were taken at the liquid pool

temperature of 7°C on a horizontal plain tube of 19.0 mm outside diameter with heat fluxes of 10 kW/m² to 80 kW/m² with an interval of 10 kW/m² in the decreasing order of heat flux.

3.1 HTC's of nonazeotropic binary mixture

Figure 3 shows nucleate boiling HTC, GTD, and $(y-x)$ which is the vapor and liquid phase composition difference for a given bulk composition of propane/isobutane mixture as a function of composition for four heat fluxes of 20, 40, 60, and 80 kW/m². Also shown in this figure are the ideal HTC's, h_{id} , calculated by a linear mole fraction weighting of pure components' measured HTC's and also HTC's of equivalent pure fluids, h_{epf} , obtained by evaluating a pure fluid's nucleate boiling heat transfer correlation using the physical properties of mixtures at various compositions at 80 kW/m². Thus calculated HTC's of mixtures include the effect of non-linear variations in the physical properties on HTC's as explained by Collier and Thome (1996). For the calculation of h_{epf} , Jung et al.'s correlation for

pure refrigerants, Eq. (1), was used which was developed using thirteen pure halogenated and hydrocarbon refrigerants' data including propane, isobutane, and HFC134a (Jung et al., 2004). The average deviation of this correlation was 5.3% for all pure refrigerants tested.

$$h = 41.4 \frac{k_f}{D_b} \left[\frac{(q/A) D_b}{k_f T_{sat}} \right]^{C_1} (-\log_{10} Pr)^{-1.52} \left(1 - \frac{\rho_g}{\rho_f} \right)^{0.53} \quad (1)$$

$$C_1 = 0.835 (1 - Pr)^{1.33} \quad (2)$$

$$D_{bi} = 0.0146 \beta \left[\frac{2\sigma}{g(\rho_f - \rho_g)} \right]^{0.5} \quad (3)$$

For the nonazeotropic mixture of propane/isobutane, HTC's showed up to 41% degradation from h_{id} as the GTD or $(y-x)$ increases. The reduction in heat transfer from the ideal values is seen over the entire composition range since the mixture is nonazeotropic. This unique phenomenon has been well observed in the past for other mixtures as well and is known to be mainly caused by the loss of available wall superheat and mass transfer resistance (Collier and Thome, 1996; Balakrishnan, 1998; Jung et al., 2003b; Stephan and Körner, 1969; Happel and Stephan, 1974).

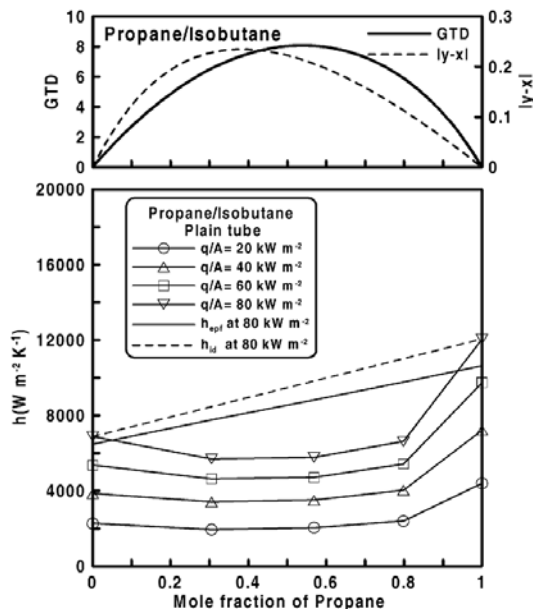

Fig. 3 Nucleate boiling HTC, GTD, $(y-x)$ of propane/isobutane mixture

3.2 HTC's of azeotropic binary mixtures

Figures 4 and 5 show nucleate boiling HTC, GTD, and $(y-x)$ of HFC134a/isobutane and propane/HFC134a mixtures as a function of com-

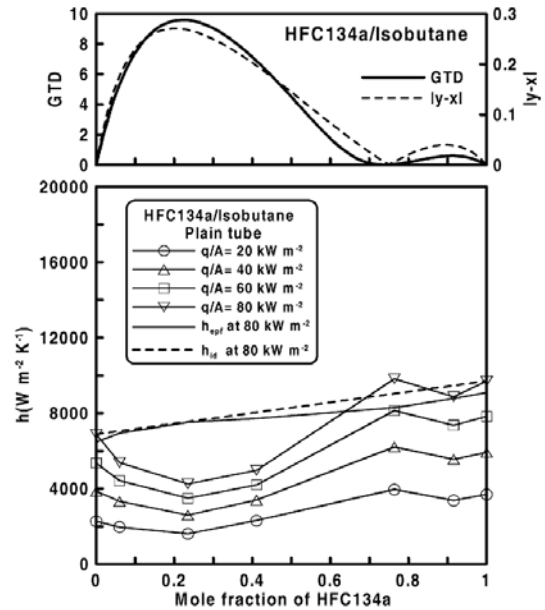

Fig. 4 Nucleate boiling HTC, GTD, $(y-x)$ of HFC134a/isobutane mixture

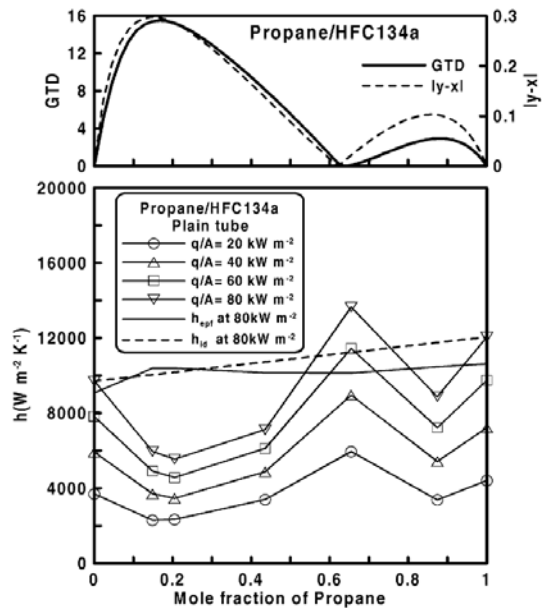

Fig. 5 Nucleate boiling HTC, GTD, $(y-x)$ of propane/HFC134a mixture

position for four heat fluxes of 20, 40, 60, and 80 kW/m². Also shown in these figures are the ideal HTC, h_{id} and HTC of equivalent pure fluids, h_{epf} at various compositions at 80 kW/m². Once again, Jung et al.'s correlation for pure refrigerants, Eq. (1), was used for the calculation of h_{epf} . Both mixtures showed significant reduction of up to 46% from the ideal values in heat transfer at the compositions where GTD or $(y-x)$ is large. HTCs of these mixtures, however, were similar to or even greater than the ideal values at about the azeotropic compositions where GTD and $(y-x)$ are 0.0 as shown in Figs. 4 and 5. This is expected since azeotropes exert no mass transfer resistance and act as if they were pure fluids. Happel and Stephan (1974) have already shown this kind of behavior for the azeotropic mixture of ethanol and benzene. Jung et al. (2003b) also observed the same behavior for HFC32/HFC125 mixture.

HTCs at the azeotropic compositions are even higher than the ideal values as seen in Figs. 4 and 5 and this is due to the variation of vapor pressure when pure components are mixed. In general, when halogenated and hydrocarbon refrigerants form an azeotrope, the vapor pressure at the azeotropic composition is higher than those of pure components. Hence the vapor pressure of HFC134a/isobutane at the azeotropic composition is higher than those of HFC134a and isobutane as shown in Fig. 6. Of course, the same thing can be said of propane/HFC134a mixture as well. This is easily demonstrated by REFPROP (1998). It is well known that nucleate boiling HTCs increase with vapor pressure (Jung et al., 2003a ; 2004 ; Rohsenow and Hartnett, 1985) and hence measured HTCs of HFC134a/isobutane and propane/HFC134a showed the right trend of increase at about azeotropic compositions due to the increased vapor pressure as demonstrated in Figs. 4 and 5. Finally, the absolute reduction from the ideal values for propane/HFC134a is greater than that for HFC134a/isobutane since the mass transfer resistance of propane/HFC134a is larger than that of HFC134a/isobutane as indicated by the larger GTDs or $(y-x)$ of propane/HFC134a as shown in Table 1.

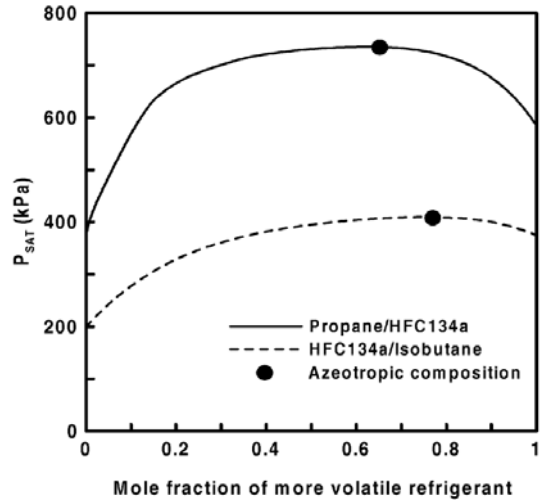

Fig. 6 Saturation pressure of liquid at 7°C for propane/HFC134a and HFC134a/isobutane mixtures

3.3 Comparison with correlations

Much research had been carried out to explain the reduction of nucleate boiling HTCs of non-azeotropic mixtures for the past. The correlations developed through various research efforts usually take into account the reduction of HTCs associated with nonazeotropic mixtures with an introduction of certain factors responsible for the change. Figure 7 shows the temperature and

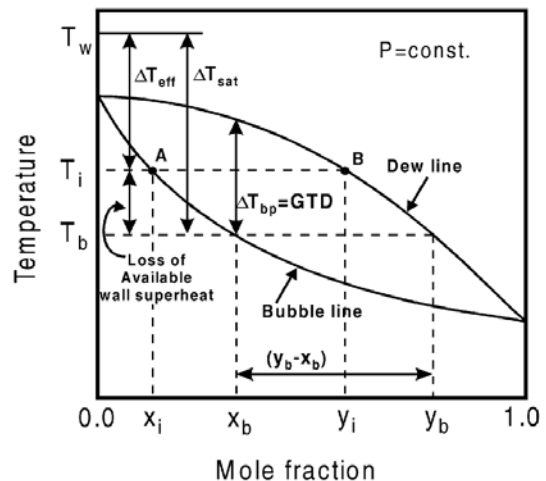

Fig. 7 Temperature and composition profiles for the nucleation of a nonazeotropic binary mixture

composition profiles for the bubble nucleation of a nonazeotropic mixture. At the bulk liquid composition of x_b , a bubble is generated and the liquid layer around the bubble has the composition of x_i (point A) whose equilibrium composition for the vapor is y_i (point B). Thus, the available wall superheat decreases from $(T_w - T_b)$ to $(T_w - T_i)$. This phenomenon is called the loss of available wall superheat which is present with any nonazeotropic mixture at all compositions. Since there is a concentration gradient near the boundary layer where bubbles develop, the more volatile component must overcome this gradient before the generation of bubbles. In other words, the concentration gradient plays as a resistance to the heat transfer and this is termed the mass transfer resistance (Collier and Thome, 1996; Thome, 1983; Thome and Shakir, 1987; Inoue et al., 1998).

Many nucleate boiling heat transfer correlations developed for nonazeotropic mixtures use the composition difference between the vapor and liquid phases, $(y-x)$ and/or GTD (ΔT_{bp}) to account for the mixture effect. In general, the mixture correlation can be expressed as follows :

$$\frac{h}{h_{id}} = \frac{1}{(1+K)} \tag{4}$$

where K is a factor representing the heat transfer reduction.

In this paper, five correlations made by Stephan and Körner (1969), Schlünder (1986), Thome (1983), Thome and Shakir (1987), and Jung et al.(2003b) are compared against the measured data. Details of the correlations were already explained in our previous paper (Jung et al., 2003b) and hence they will not be repeated here.

In the application of these correlations, prediction of nucleate boiling HTC is required for

pure components' and/or equivalent pure fluids at various compositions for mixtures. In refrigeration industry, both Stephan and Abdelsalam's (1980) and Cooper's correlations for pure refrigerants (1984) have been popular but recently Jung et al.(2004) showed that these correlations predicted very poorly the nucleate boiling HTCs of hydrocarbons with 70–80% deviation. Therefore, in the comparison presented in this paper, Jung et al's correlation, Eq. (1), is used throughout for the prediction of nucleate boiling HTCs for pure components' or equivalent pure fluids for mixtures.

Table 3 shows the result of comparison between the above mentioned five correlations and present data with three binary mixtures. Except Thome's correlation, other four correlations predicted the present mixture data within 15% mean deviation. Figures 8 and 9 show the comparison between Stephan and Körner's (1969) and Jung et al's (2003b) correlations since they predicted the data well. All symbols in these figures are given in Table for reference. For the nonazeotropic propane/isobutane mixture, the mean deviations of these two correlations were less than 7%. For the azeotropic HFC134a/isobutane and propane/HFC134a mixtures, the mean deviations were less than 14% for all data except those at azeotropic compositions. The mean deviations at the azeotropic compositions (symbols G and L in Figs. 8 and 9) were 20 and 30% for HFC134a/isobutane and propane/HFC134a respectively.

This has to do with the pressure rise at the azeotropic compositions as seen in Fig. 7. The prediction equation for nucleate boiling heat transfer by Jung et al., Eq. (1), is based upon Cooper's approach utilizing corresponding states principles (Cooper, 1984) and hence requires reduced pressures and consequently critical pres-

Table 3 Comparison of the present data with various correlations

	Stephan & Körner	Schlünder	Thome	Thome & Shakir	Jung et al.
Avg. dev.(%)	-8.16	-3.30	-27.22	-14.42	-8.46
Mean dev.(%)	11.13	13.28	27.22	-15.07	11.05

$$\text{Avg. dev.} = \frac{1}{n} \sum_1^n \left[\frac{(h_{cal} - h_{exp}) \times 100}{h_{exp}} \right], \text{ Mean dev.} = \frac{1}{n} \sum_1^n \text{ABS} \left[\frac{(h_{cal} - h_{exp}) \times 100}{h_{exp}} \right]$$

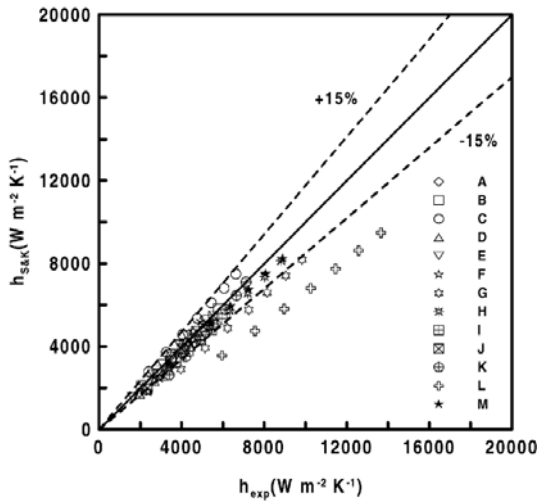

Fig. 8 Comparison of Stephan and Körner's correlation against the binary mixture data

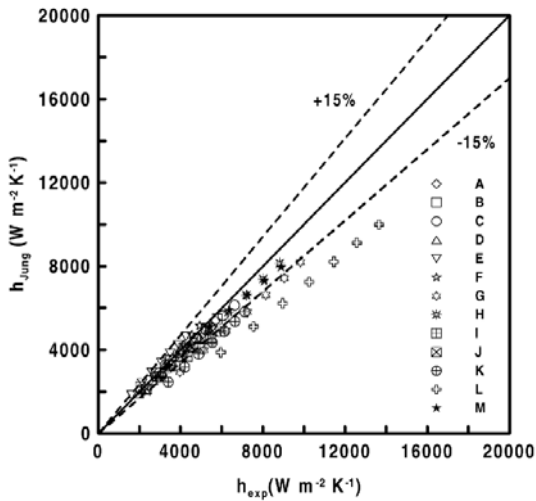

Fig. 9 Comparison of Jung et al.'s correlation against the binary mixture data

tures at various compositions of mixtures. In this paper, the critical pressures of the mixtures were all estimated by REFPROP (1998). It is, however, well known that estimating critical pressures of mixtures easily involves 10~15% error (Reid et al., 1977). This kind of uncertainty would result in a large deviation in the prediction of nucleate boiling HTC's of azeotropic mixtures at azeotropic compositions. In fact, when the critical pressures of the mixtures were evaluated by a linear mole fraction weighting of

pure components' critical pressures, Jung et al.'s correlation predicted the present data with 7.7% mean deviation with a maximum mean deviation of 17% instead of 30% at the azeotropic composition for propane/HFC134a mixture. This clearly shows the effect of reduced pressures or critical pressures of mixtures on the prediction of mixture HTC's.

4. Conclusions

In this study, nucleate pool boiling heat transfer coefficients (HTCs) were measured with one nonazeotropic mixture of propane/isobutane and two azeotropic mixtures of HFC134a/isobutane and propane/HFC134a. All data were taken at the liquid pool temperature of 7°C on a horizontal plain tube of 19.0 mm outside diameter with heat fluxes of 10 kW/m² to 80 kW/m² with an interval of 10 kW/m² in the decreasing order of heat flux. Through the analysis of the data, following conclusions are drawn.

- (1) The nonazeotropic mixture of propane/isobutane showed a reduction of HTC's as much as 41% from the ideal values. The reduction in heat transfer is seen over the entire composition range.
- (2) The azeotropic mixtures of HFC134a/isobutane and propane/HFC134a showed a reduction of HTC's as much as 44% from the ideal values at all compositions other than azeotropic ones. At azeotropic compositions, however, the HTC's were even higher than the ideal values due to the increase in the vapor pressure.
- (3) For all mixtures, the reduction in heat transfer was greater with larger gliding temperature difference.
- (4) Stephan and Körner's and Jung et al.'s correlations predicted the HTC's of mixtures with a mean deviation of 11%. The largest mean deviation occurred at the azeotropic compositions of HFC134a/isobutane and propane/HFC134a.

Acknowledgments

This work was supported by INHA UNIVER-

SITY Research Grant in 2006'

References

- Balakrishnan, A. R., 1998, "Pool Boiling of Saturated Pure Liquids and Binary Mixtures: Effects of Surface Characteristics," *Proc. of the 11th Int. Heat Transfer Conf. 1998*, Kyongju, pp. 71~87.
- Collier, J. H. and Thome, J. R., 1996, "Convective Boiling and Condensation," 3rd ed. Oxford University Press, pp. 535~584.
- Cooper, M. G., 1984, "Heat Flow Rates in Saturated Nucleate Pool Boiling — a Wide-Ranging Examination using Reduced Properties," *Advances in Heat Transfer*, Academic Press, Vol. 16, pp. 157~239.
- Gorenflo, D., 2001, "State of the Art in Pool Boiling Heat Transfer of New Refrigerants," *Int. J. Refrigeration*, Vol. 24, pp. 6~14.
- Happel, O. and Stephan, K., 1974, "Heat Transfer From Nucleate to Beginning of Film Boiling in Binary Mixtures," *Proc. of the 5th Int. Heat Transfer Conf. 1974*, Tokyo (Paper B7.8).
- Inoue, T., Kawae, N. and Monde, M., 1998, "Characteristics of Heat Transfer Coefficient During Nucleate Pool Boiling of Binary Mixtures," *Heat and Mass Transfer*, Vol. 33, pp. 337~44.
- Int. Energy Agency's Heat Pump Center, Informative fact sheet: Hydrocarbons as refrigerants in residential heat pumps and air-conditioners, 2002.
- Jung, D., Kim, C., Song, K. and Park, B., 2000, "Testing of Propane/Isobutane Mixture in Domestic Refrigerators," *Int. J. Refrigeration*, Vol. 23, pp. 517~527.
- Jung, D., Kim, Y., Ko, Y. and Song, K., 2003a, "Nucleate Boiling Heat Transfer Coefficients of Pure Halogenated Refrigerants," *Int. J. Refrigeration*, Vol. 26, pp. 240~248.
- Jung, D., Lee, H., Bae, D. and Oho, S., 2004, "Nucleate Boiling Heat Transfer Coefficients of Flammable Refrigerants," *Int. J. Refrigeration*, Vol. 27, pp. 409~414.
- Jung, D., Park, B. and Lee, H., 1999, "Evaluation of Supplementary/Retrofit Refrigerants for Automobile Air-Conditioners Charged with CFC12," *Int. J. Refrigeration*, Vol. 22, pp. 558~568.
- Jung, D., Song, K., Ahn, K. and Kim, J., 2003b, "Nucleate Boiling Heat Transfer Coefficients of Mixtures Containing HFC32, HFC125, and HFC134a," *Int. J. Refrigeration*, Vol. 26, pp. 764~771.
- Kline, S. J. and McClintock, F. A., 1953, "Describing Uncertainties in Single-Sample Experiments," *Mechanical Engineers*, Vol. 75, pp. 3~9.
- Kruse, H., 1996, "The State of the Art of the Hydrocarbon Technology in Household Refrigeration," *Proc. of the Int. conferences on ozone protection technologies*, Washington (DC), pp. 179~188.
- NIST thermodynamic and transport properties of refrigerants and refrigerant mixtures — REFPROP version 6.0, 1998, Gaithersburg (MD 20899), US National Institute of Standards and Technology.
- Reid, R. C., Prausnitz, J. M. and Sherwood, T. K., 1977, "The Properties of Gases and Liquids," 3rd ed. McGraw-Hill, pp. 145~149.
- Rohsenow, W. M., Hartnett, J. P. and Ganic, E. N., 1985, "Handbook of Heat Transfer Fundamentals," 2nd ed. McGraw-Hill, Chapter 12, p. 22.
- Schlünder, E. U., 1986, "Heat Transfer in Nucleate Boiling of Mixtures," *Proc. of the 8th Int. Heat Transfer Conf.*, Vol. 4, San Francisco, pp. 2073~2079.
- Stephan, K. and Abdelsalam, M., 1980, "Heat Transfer Correlations for Natural Convection Boiling," *Int. J. Heat Mass Transfer*, Vol. 23, pp. 73~87.
- Stephan, K. and Körner, M., 1969, "Calculation of Heat Transfer in Evaporating Binary Liquid Mixtures," *Chemie-Ingenieur Technik*, Vol. 41, No. 7, pp. 409~417.
- Thome, J. R., 1983, "Prediction of Binary Mixture Boiling Heat Transfer Coefficients using Only Equilibrium Data," *Int. J. Heat Mass Transfer*, Vol. 26, No. 7, pp. 965~974.
- Thome, J. R., 1996, "Boiling of New Refri-

gerants : a State-of-the-art-review," *Int. J. Refri-*
geration, Vol. 19, pp. 435~457.

Thome, J. R. and Shakir, S., 1987, "A New

Correlation for Nucleate Pool Boiling of Aque-

ous Mixtures," *AIChE Symposium Series*, Vol.
83, No. 257, pp. 46~51.